

MTVA

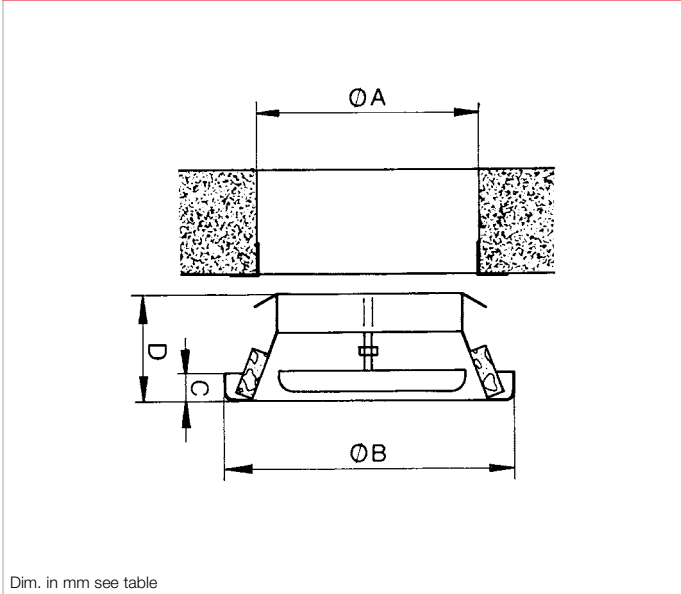

Dimensions MTVA



Application

For extract air operation in rooms of any kind and especially where ventilation components made of non-combustible material are stipulated. Can be used for low to high flow velocities. Low-noise.

Airtight closure of the opening circumferential foam ring to prevent air leakage from the side. Contamination of the surrounding environment is thereby prevented.

Advantages

- High-quality metal design in aerodynamic form with low noise levels.
- Wide cover and optimised height of the inlet ring prevent dirty marks.
- Installation in ceilings and walls within seconds and without tools.
- Plaster and difference compensation in case of unevenness, diameter differences or ducts that have been mounted too deep.
- Clamp spring holder allows direct insertion in ducts or walls with thickness of approx. 20 mm or more without additional mounting ring.

Delivery

Each valve in separate polybag.

Accessories

Mounting rings (see table) are required for installation in sheet metal duct walls and thin panels.

Installation

Set to desired volume flow pursuant to diagrams above. Distance "A" is specified in mm from the origin. Valve insertion in duct or wall opening.

Performance data

The diagrams provide an overview of the air volumes, resistances and noise levels at corresponding settings for distance "A" in mm.

Design

Metal design with high-quality finish in white. Protected against corrosion with epoxy powder coating.

Volume adjustment

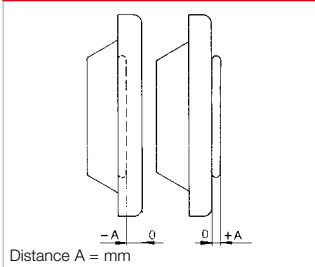

MTVA 125

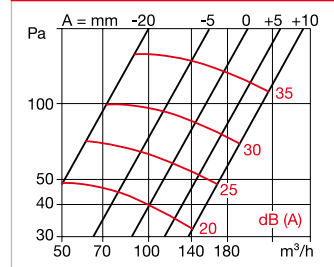

MTVA 75/80

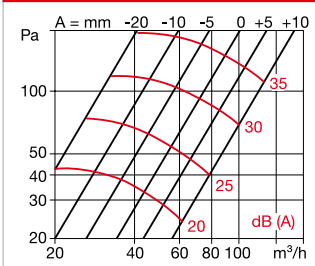

MTVA 160

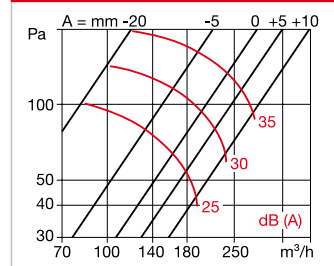

MTVA 100

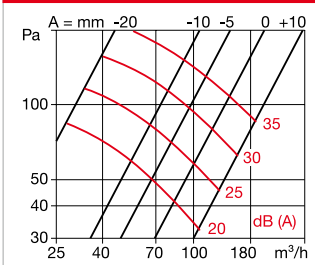

MTVA 200

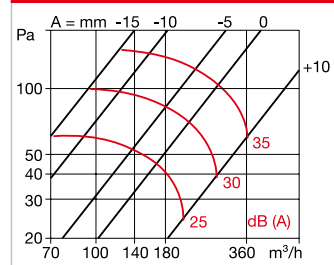

Order data

Type	MTVA 75/80	MTVA 100	MTVA 125	MTVA 160	MTVA 200
Ref. no.	08868	08869	08870	08871	08872
Ø A mm	73 – 85	95 – 105	120 – 130	150 – 165	195 – 205
Ø B mm	108	135	160	195	230
C mm	15	15	15	15	15
D mm	58	55	55	58	55
Weight in g	150	190	405	340	450

Mounting ring

Type	EBR 75/80	EBR 100	EBR 125	EBR 160	EBR 200
Ref. no.	00952	00953	00954	00955	00956
for NW (mm)	75/80	100	125	150/160	200