

184,5

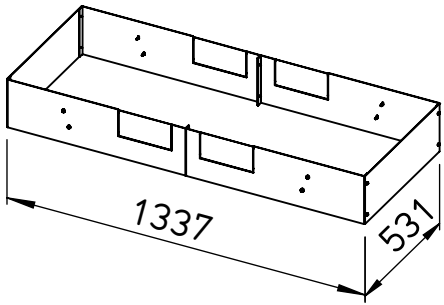

1337

537