

EC 100/35 SS-1162

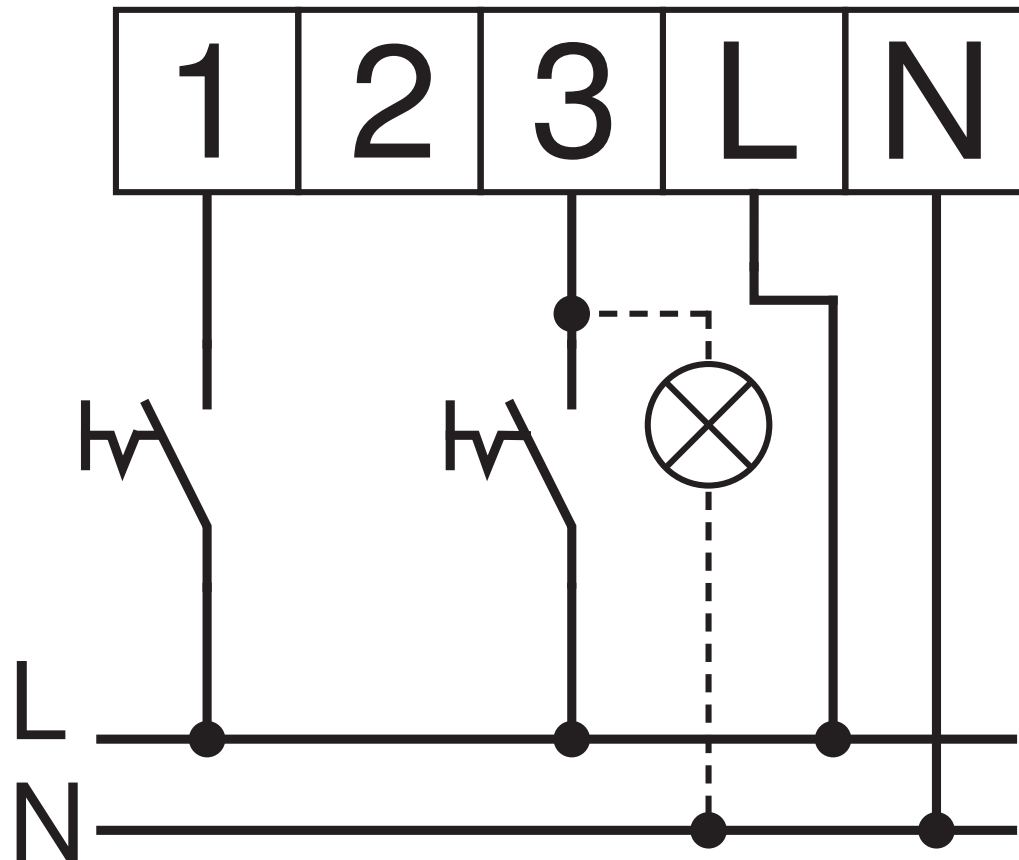

3	100 m ³ /h
1	35 m ³ /h