

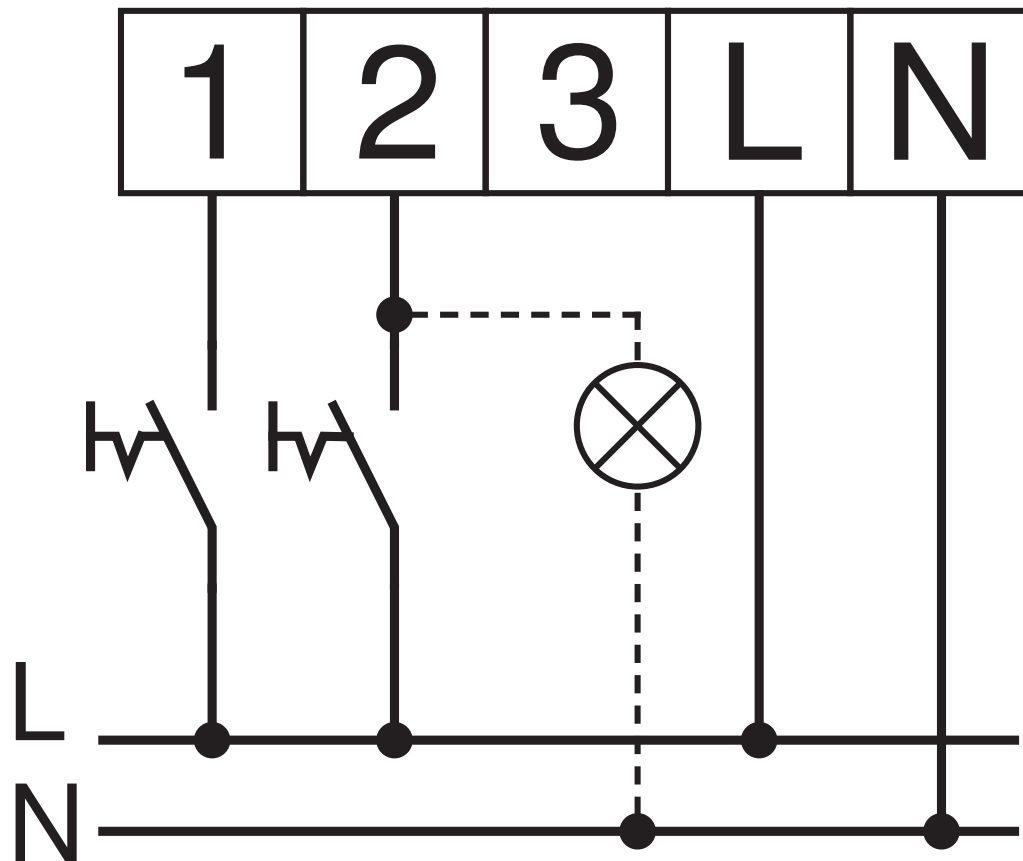

EC 60/35 N

SS-1188



2	60 m <sup>3</sup> /h	
1	35 m <sup>3</sup> /h	