

EC 60/40/15 SS-1200

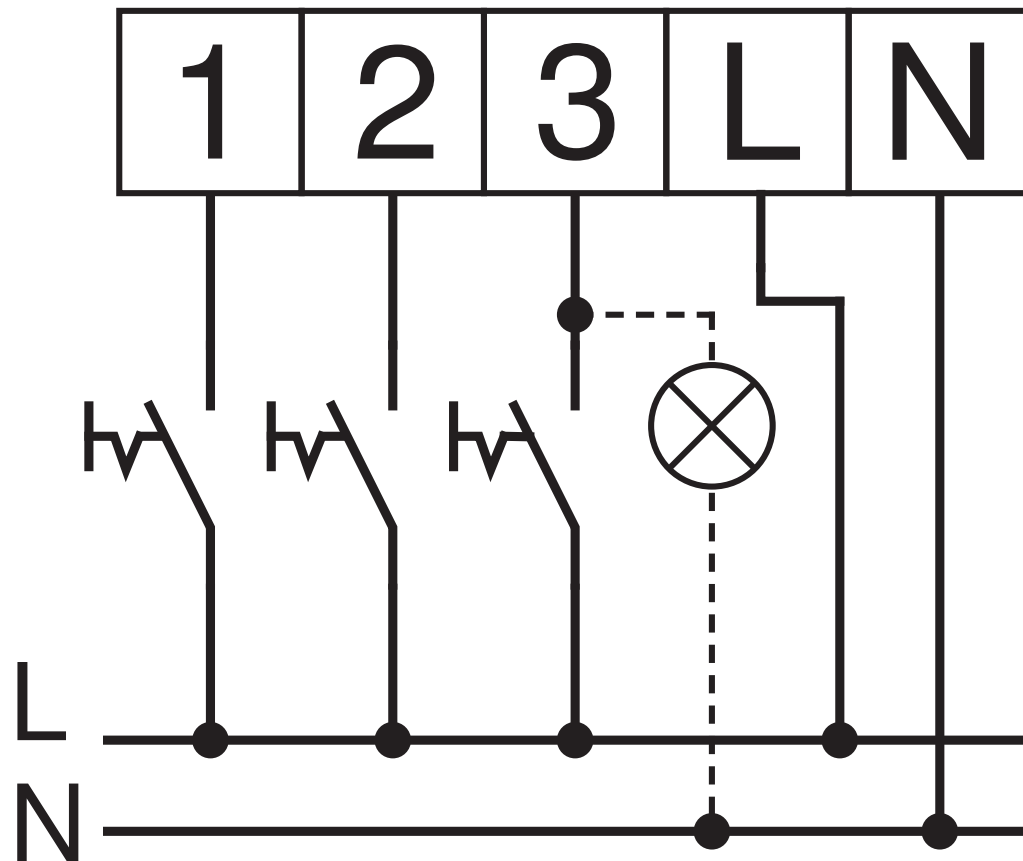

3	60 m ³ /h
2	40 m ³ /h
1	15 m ³ /h