

Batterie de post-chauffage électrique

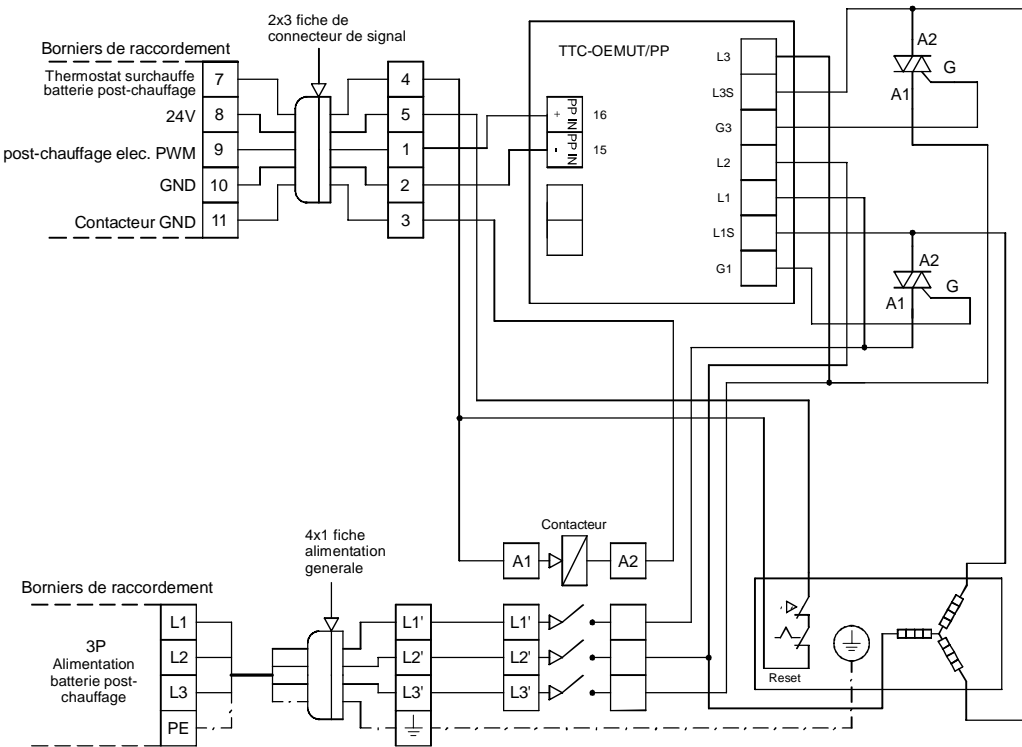

Pompe

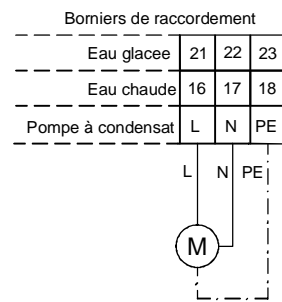

AIR1-BE TOUCH

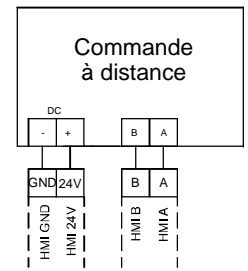

BACNET & MODBUS

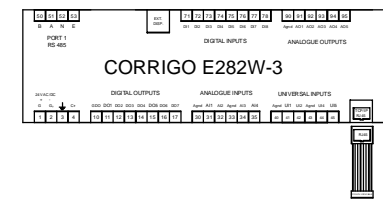

Sondes de qualité d'air

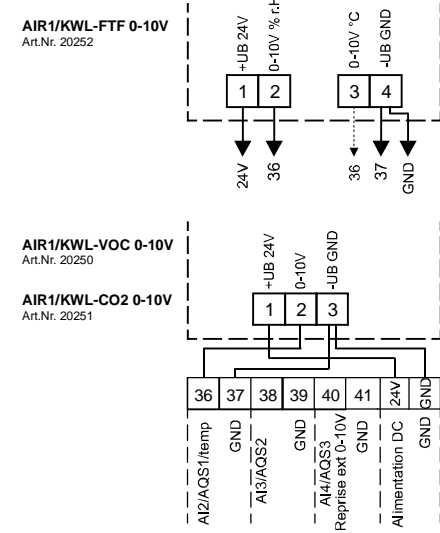

Air1 CO2 K

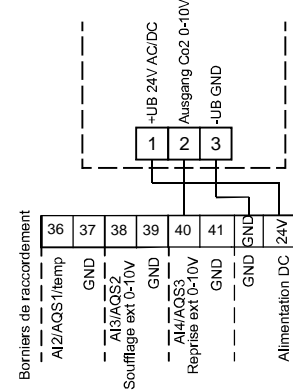

Alimentation generale

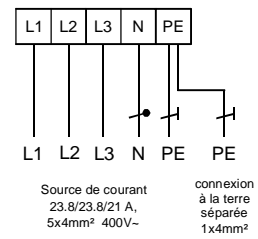

36-37: Sonde de qualité d'air 1 ou capteur de température (sortie de température AIR1/KWL-FTF 0-10V)
 38-39: Sonde de qualité d'air 2
 40-41: Sonde de qualité d'air 3

