

42-43: Luftqualitätssensor 1 oder Temperatur-Sensor (Temperatursignal AIR1/KWL-FTF 0-10V)
 44-45: Luftqualitätssensor 2
 46-47: Luftqualitätssensor 3

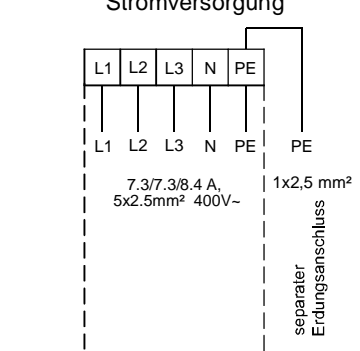

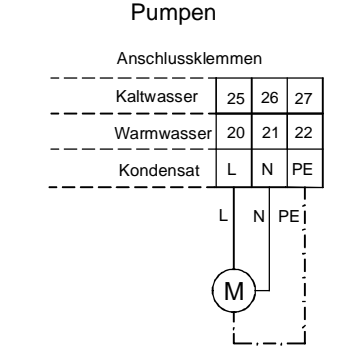
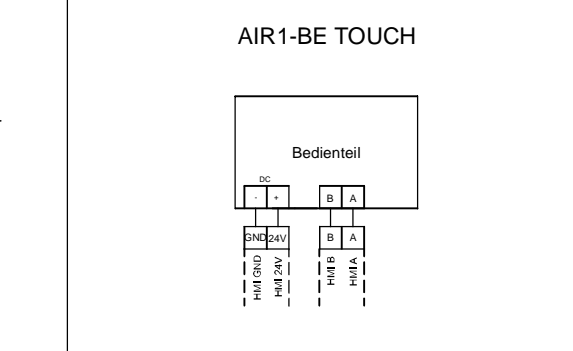
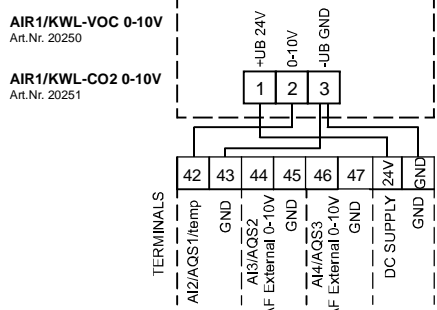
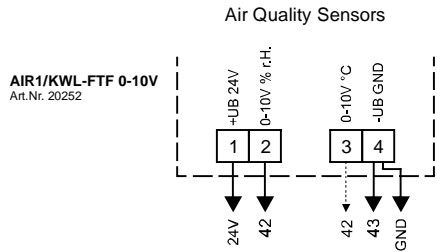
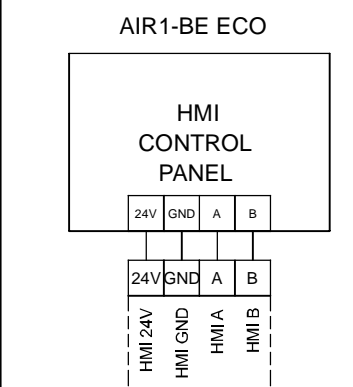
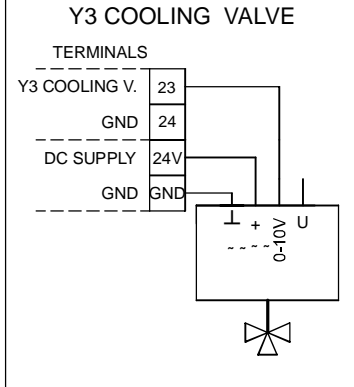
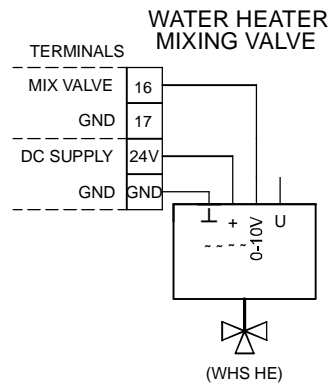
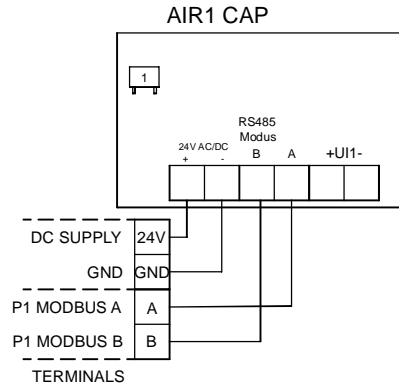
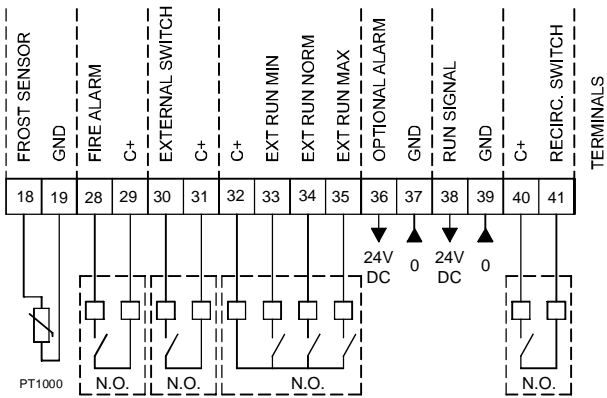

42-43: Air Quality Sensor 1 or temperature sensor (temp output AIR1/KWL-FTF 0-10V)

44-45: Air Quality Sensor 2

46-47: Air Quality Sensor 3

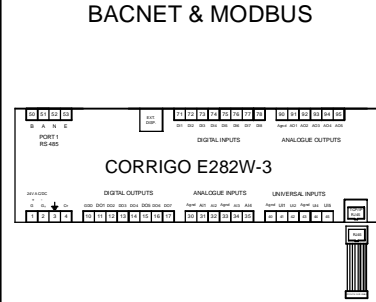
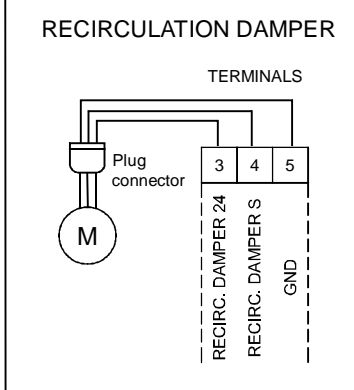
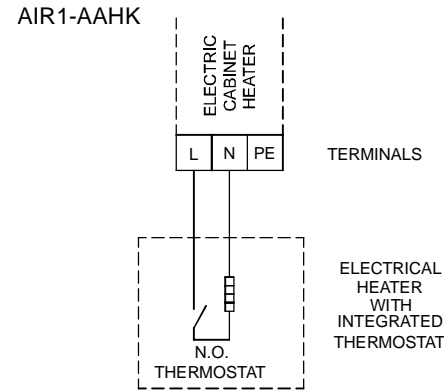
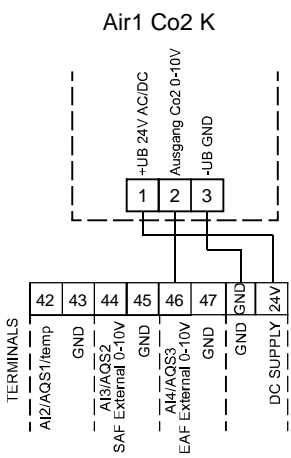

AIR1-BE TOUCH

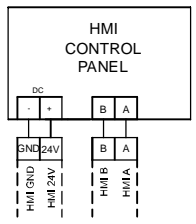

PUMP WW/CW/DRAINAGE

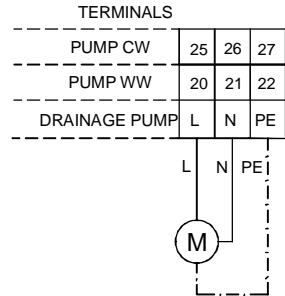

UNIT POWER SUPPLY

