

Versorgung 1~ Geräte

Anschlussklemmen

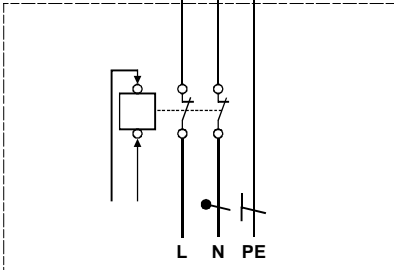
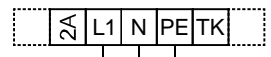

Optional: Bauseits bei raumluftabhängigen Feuerstätten zu erstellen!
Signal der Sicherheitseinrichtung siehe MBV.

Max. Strom der 24V Versorgung: 0,54 A Strom der Einzel-Komponenten: WSH - 104 mA
CO2 - 25 mA, Peakstrom 200 mA
FTF - 25 mA
VOC - 25 mA
BWM - 41 mA

Anschlussmöglichkeiten für 1~ und 3~ Geräte

Mischerventil

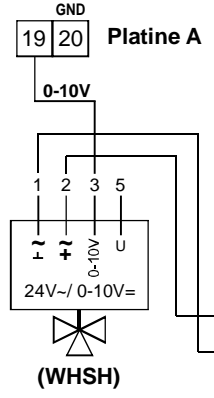

Anschlussklemmen

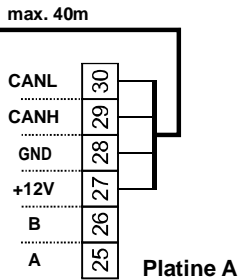
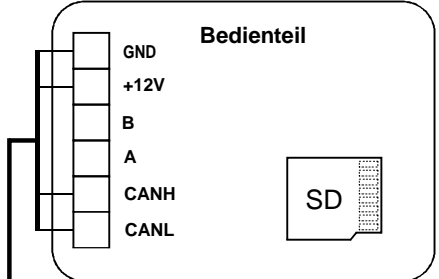

Luftqualitätssensor

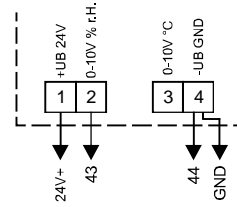

AIR1/KWL-FTF 0-10V
Art.Nr. 20252

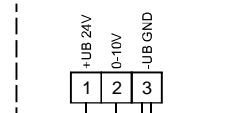

AIR1/KWL-VOC 0-10V
Art.Nr. 20250

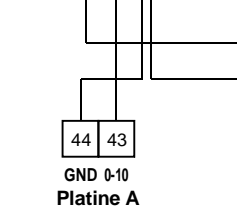

AIR1/KWL-CO2 0-10V
Art.Nr. 20251

Anschlussklemmen

Versorgung 3~ Geräte

Anschlussklemmen

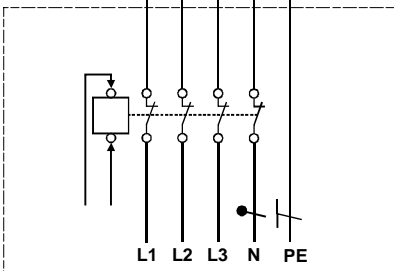
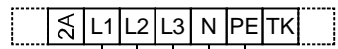

Optional: Bauseits bei raumluftabhängigen Feuerstätten zu erstellen!
Signal der Sicherheitseinrichtung siehe MBV.

Platine A

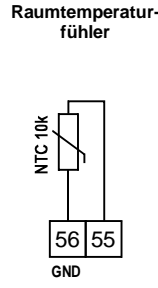
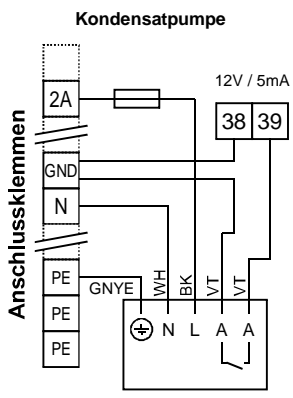
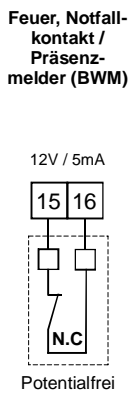
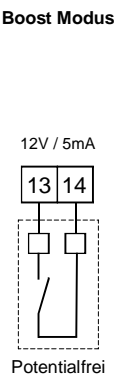
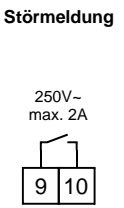

Platine B

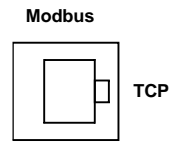
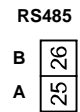
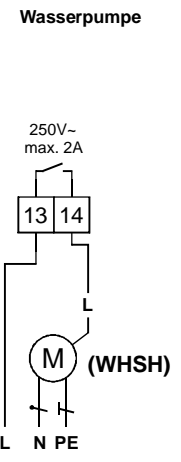

Supply 1~ devices

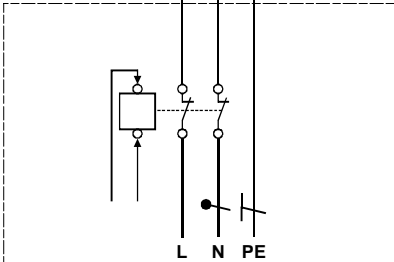
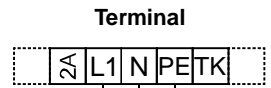

Optional: To be establish-ed on site for room air dependent fireplaces!
Signal of safety device: See manual.

Max. Current of the 24V supply: 0.54 A Current of individual components: WSH - 104 mA
CO2 - 25 mA, peak current 200 mA
FTF - 25 mA
VOC - 25 mA
BWM - 41 mA

Connection options for 1 ~ and 3 ~ devices

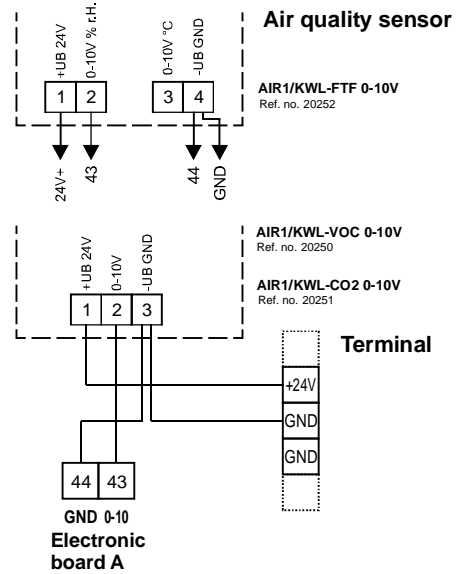
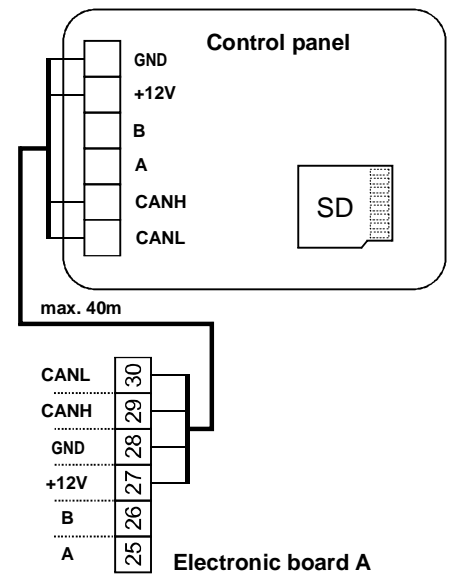
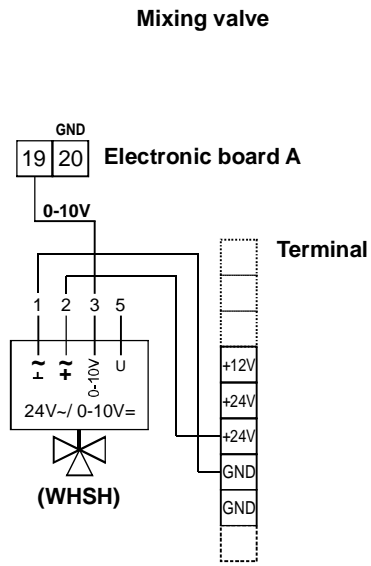

Supply 3~ devices

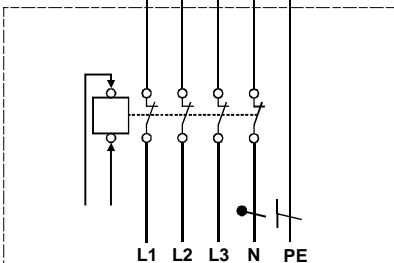
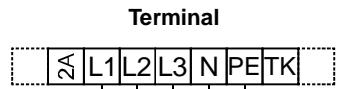

Optional: To be establish-ed on site for room air dependent fireplaces!
Signal of safety device: See manual.

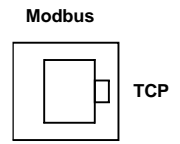
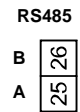
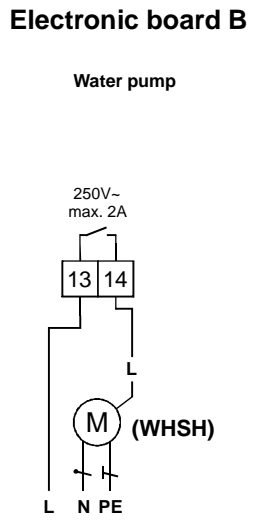
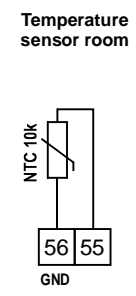
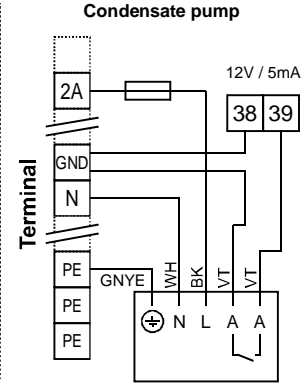
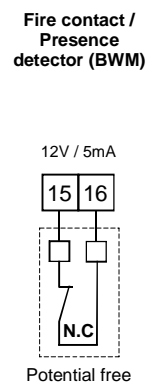
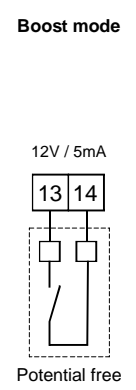
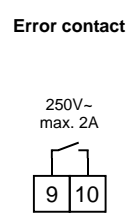
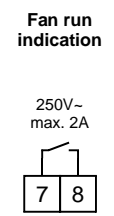

Fournir 1~ appareils

Bornes de raccordement

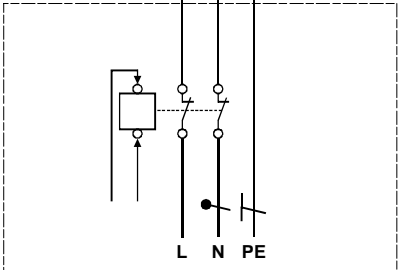
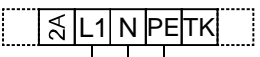

En option : à prévoir sur place pour les appareils de chauffage prenant l'air comburant dans la pièce! Signal relatif au dispositif de sécurité, voir manuel d'utilisation.

Courant max de l'alimentation 24V: 0,54 A

Courant des différents composants: WSH - 104 mA
 CO2 - 25 mA, courant de pointe 200 mA
 FTF - 25 mA
 VOC - 25 mA
 BWM - 41 mA

Vanne de mélange

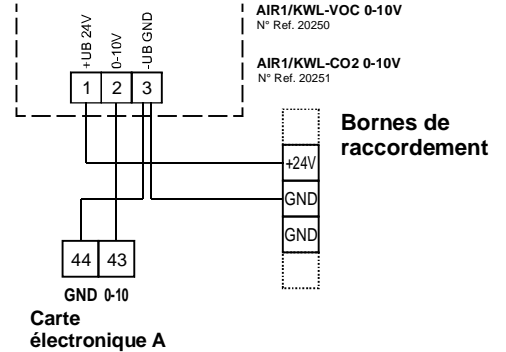
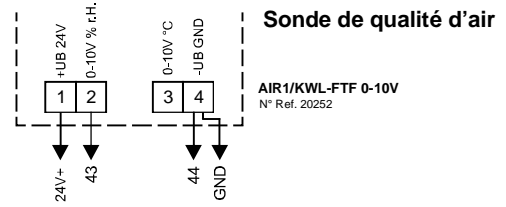
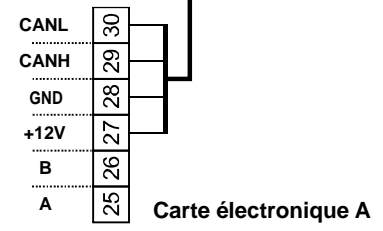
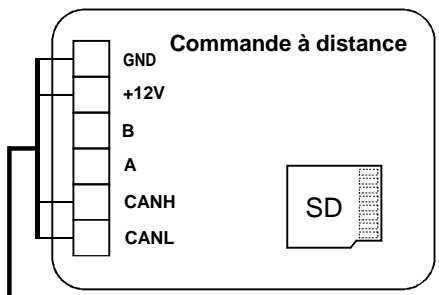
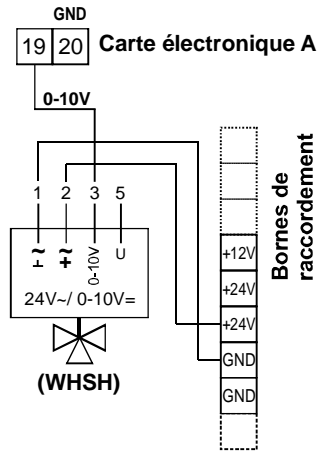

Options de connexion pour les appareils 1 ~ et 3 ~

Fournir 3~ appareils

Bornes de raccordement

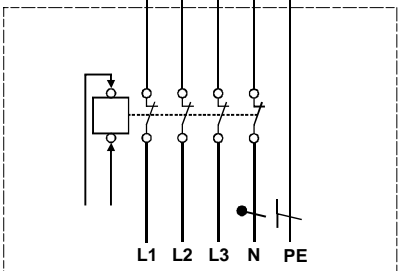
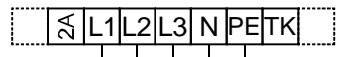

En option : à prévoir sur place pour les appareils de chauffage prenant l'air comburant dans la pièce! Signal relatif au dispositif de sécurité, voir manuel d'utilisation.

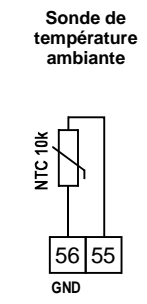
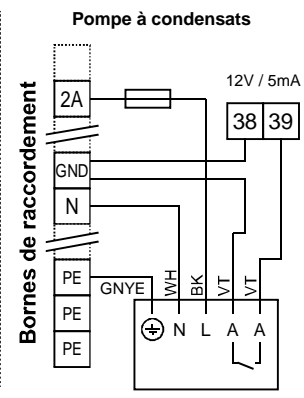
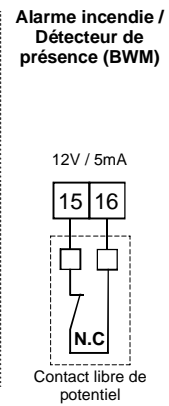
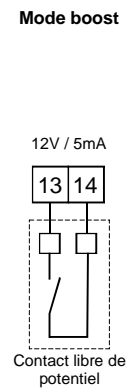
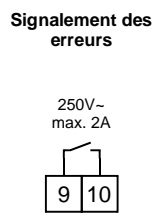
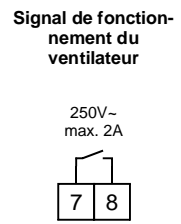

Carte électronique B

