

Air Quality Sensors

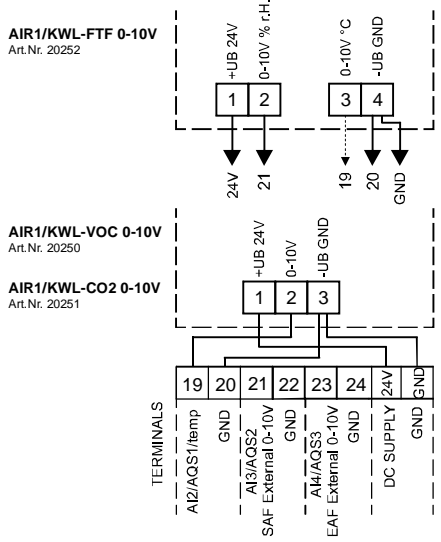

Air1 Co2 K

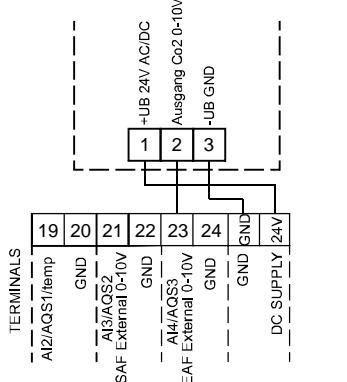

19-20: Air Quality Sensor 1 or temperature sensor (temp output AIR1/KWL-FTF 0-10V)
21-22: Air Quality Sensor 2
23-24: Air Quality Sensor 3

ODA/EHA DAMPER

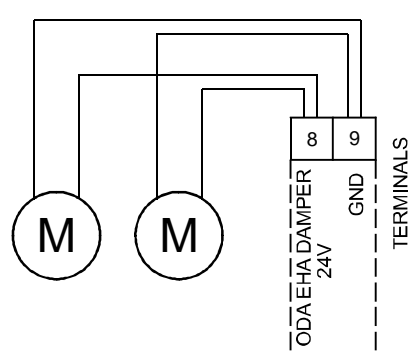

PUMP WW/CW/DRAINAGE

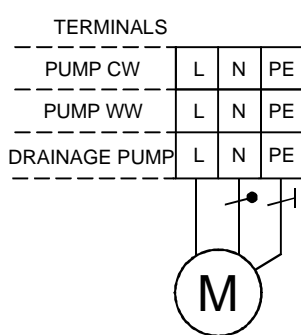

UNIT POWER SUPPLY

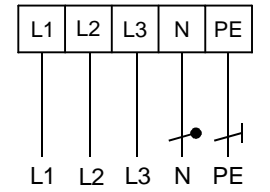

Cable cross-section: 4mm²

DX UNIT

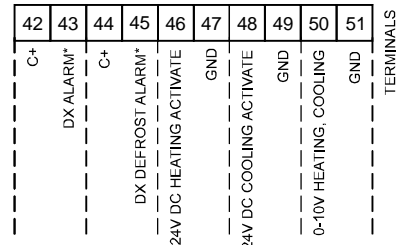

*potential free

AIR1-BE TOUCH 2

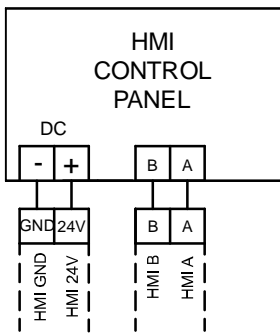

AIR1-BE ECO

